



SWIMMING POOL HEAT PUMP

Installation & Instruction Manual



IMPORTANT NOTE:

Thank you very much for purchasing our product. Before using your unit, please read this manual carefully and keep it for future reference.

CONTENT

1. FOREWORD.....	1
1.1. Read the Manual Before Operation.....	1
1.2. The Symbol Description of the Device.....	6
1.3. Statement.....	6
1.4. Safety Factors.....	6
2. OVER VIEW OF THE UNIT.....	8
2.1. Accessories Supplied With the Unit.....	8
2.2. Dimensions of the Unit.....	8
2.3. Main Parts of the Unit.....	9
2.4. Parameter of the Unit.....	11
3. INSTALLATION AND CONNECTION.....	12
3.1. Transportation.....	12
3.2. Notice Before Installation.....	12
3.3. Installation Instruction.....	13
3.3.1 Pre-requirements.....	13
3.3.2 Heat Pump Installation.....	13
3.3.3 Location and Size.....	14
3.3.4 Installation Layout.....	15
3.3.5 Electrical Installation.....	16
3.3.6 Electrical Connection.....	16
3.4. Trial After Installation.....	17
3.4.1 Inspection Before Trial Running.....	17
3.4.2 Trial Running.....	17
4. CONTROLLER OPERATION.....	18
4.1. Control Panel Diagram.....	18
4.2. Key Operating Instruction.....	19
4.2.1 Target temperature setting.....	19
4.2.2 ON/OFF Function.....	19
4.2.3 Mode Selection Function.....	20
4.2.4 Frequency settings.....	20
4.2.5 Lock screen function.....	21
4.2.6 Current faults.....	21
4.2.7 Status Inquiry.....	22
4.2.8 Setting interface.....	22

4.2.9 Curve.....	27
4.3. User Parameters.....	28
4.4. Fault & Protections.....	31
5. Wi-Fi Settings.....	32
5.1 Download and Register.....	32
5.2 Add device and share device.....	33
5.3 Software function operation.....	36
5.4 Modify Device Name/Delete Device.....	38
5.5 Timing.....	39
5.6 Set Parameters.....	40
5.7 Mine.....	43
6. MAINTENANCE AND WINTERZING.....	44
6.1 Maintenance.....	44
6.2 Winterizing.....	44
7. Warranty Information	45

1. FOREWORD

1.1. Read the Manual Before Operation

WARNING

Do not use means to accelerate the defrosting process or to clean, other than those recommended by the manufacturer. The appliance shall be stored in a room without continuously operating ignition sources (for example: open flames, an operating gas appliance or an operating electric heater).

Do not pierce or burn.

Be aware that refrigerants may not contain an odour.

Initial safety checks shall include:

- ① That capacitors are discharged: this shall be done in a safe manner to avoid possibility of sparking;
- ② That no live electrical components and wiring are exposed while charging, recovering or purging the system;
- ③ That there is continuity of earth bonding.

Checks to the area

Prior to beginning work on systems containing flammable refrigerants, safety checks are necessary to ensure that the risk of ignition is minimized. For repair to the refrigerating system, the following precautions shall be completed prior to conducting work on the system.

Work procedure

Work shall be undertaken under a controlled procedure so as to minimize the risk of a flammable gas or vapour being present while the work is being performed.

General work area

All maintenance staff and others working in the local area shall be instructed on the nature of work being carried out. Work in confined spaces shall be avoided.

Checking for presence of refrigerant

The area shall be checked with an appropriate refrigerant detector prior to and during work, to ensure the technician is aware of potentially flammable atmospheres. Ensure that the leak detection equipment being used is suitable for use with flammable refrigerants, i.e. non-sparking, adequately sealed or intrinsically safe.

Presence of fire extinguisher

If any hot work is to be conducted on the refrigerating equipment or any associated parts, appropriate fire extinguishing equipment shall be available to hand. Have a dry powder or CO₂ fire extinguisher adjacent to the charging area.

No ignition sources

No person carrying out work in relation to a refrigeration system which involves exposing any pipe work that contains or has contained flammable refrigerant shall use any sources of ignition in such a manner that it may lead to the risk of fire or explosion. All possible ignition sources, including cigarette smoking, should be kept sufficiently far away from the site of installation, repairing, removing and disposal, during which flammable refrigerant can possibly be released to the surrounding space. Prior to work taking place, the area around the equipment is to be surveyed to make sure that there are no flammable hazards or ignition risks. "No Smoking" signs shall be displayed.

Ventilated area

Ensure that the area is in the open or that it is adequately ventilated before breaking into the system or conducting any hot work. A degree of ventilation shall continue during the period that the work is carried out. The ventilation should safely disperse any released refrigerant and preferably expel it externally into the atmosphere.

Checks to the refrigeration equipment

Where electrical components are being changed, they shall be fit for the purpose and to the correct specification. At all times the manufacturer's maintenance and service guidelines shall be followed. If in doubt consult the manufacturer's technical department for assistance.

The following checks shall be applied to installations using flammable refrigerants:

- ① The charge size is in accordance with the room size within which the refrigerant containing parts are installed;
- ② The ventilation machinery and outlets are operating adequately and are not obstructed;
- ③ If an indirect refrigerating circuit is being used, the secondary circuit shall be checked for the presence of refrigerant;
- ④ Marking to the equipment continues to be visible and legible. Markings and signs that are illegible shall be corrected;
- ⑤ Refrigeration pipe or components are installed in a position where they are unlikely to be exposed to any substance which may corrode refrigerant containing components, unless the components are constructed of materials which are inherently resistant to being corroded or are suitably protected against being so corroded.

Repairs to sealed components

DD.5.1 During repairs to sealed components, all electrical supplies shall be disconnected from the equipment being worked upon prior to any removal of sealed covers, etc. If it is absolutely necessary to have an electrical supply to equipment during servicing, then a permanently operating form of leak detection shall be located at the most critical point to warn of a potentially hazardous situation.

DD.5.2 Particular attention shall be paid to the following to ensure that by working on electrical components, the casing is not altered in such a way that the level of protection is affected. This shall include damage to cables, excessive number of connections, terminals not made to original specification, damage to seals, incorrect fitting of glands, etc.

Ensure that the apparatus is mounted securely.

Ensure that seals or sealing materials have not degraded to the point that they no longer serve the purpose of preventing the ingress of flammable atmospheres. Replacement parts shall be in accordance with the manufacturer's specifications.

Repair to intrinsically safe components

Do not apply any permanent inductive or capacitance loads to the circuit without ensuring that this will not exceed the permissible voltage and current permitted for the equipment in use. Intrinsically safe components are the only types that can be worked on while live in the presence of a flammable atmosphere. The test apparatus shall be at the correct rating.

Replace components only with parts specified by the manufacturer. Other parts may result in the ignition of refrigerant in the atmosphere from a leak.

NOTE The use of silicon sealant can inhibit the effectiveness of some types of leak detection equipment.

Intrinsically safe components do not have to be isolated prior to working on them.

Cabling

Check that cabling will not be subject to wear, corrosion, excessive pressure, vibration, sharp edges or any other adverse environmental effects. The check shall also take into account the effects of aging or continual vibration from sources such as compressors or fans.

Detection of flammable refrigerants

Under no circumstances shall potential sources of ignition be used in the searching for or detection of refrigerant leaks. A halide torch (or any other detector using a naked flame) shall not be used.

Leak detection methods

The following leak detection methods are deemed acceptable for systems containing flammable refrigerants.

Electronic leak detectors shall be used to detect flammable refrigerants, but the sensitivity may not be adequate, or may need re-calibration. (Detection equipment shall be calibrated in a refrigerant-free area.) Ensure that the detector is not a potential source of ignition and is suitable for the refrigerant used. Leak detection equipment shall be set at a percentage of the LFL of the refrigerant and shall be calibrated to the refrigerant employed and the appropriate percentage of gas (25 % maximum) is confirmed.

Leak detection fluids are suitable for use with most refrigerants but the use of detergents containing chlorine shall be avoided as the chlorine may react with the refrigerant and corrode the copper pipe-work.

If a leak is suspected, all naked flames shall be removed/extinguished.

If a leakage of refrigerant is found which requires brazing, all of the refrigerant shall be recovered from the system, or isolated (by means of shut off valves) in a part of the system remote from the leak. Oxygen free nitrogen (OFN) shall then be purged through the system both before and during the brazing process.

Removal and evacuation

When breaking into the refrigerant circuit to make repairs – or for any other purpose – conventional procedures shall be used. However, it is important that best practice is followed since flammability is a consideration. The following procedure shall be adhered to:

- ① Remove refrigerant;
- ② Purge the circuit with inert gas;
- ③ Evacuate;
- ④ Purge again with inert gas;
- ⑤ Open the circuit by cutting or brazing.

The refrigerant charge shall be recovered into the correct recovery cylinders. The system shall be “flushed” with OFN to render the unit safe. This process may need to be repeated several times. Compressed air or oxygen shall not be used for this task.

Flushing shall be achieved by breaking the vacuum in the system with OFN and continuing to fill until the working pressure is achieved, then venting to atmosphere, and finally pulling down to a vacuum. This process shall be repeated until no refrigerant is within the system. When the final OFN charge is used, the system shall be vented down to atmospheric pressure to enable work to take place. This operation is absolutely vital if brazing operations on the pipework are to take place.

Ensure that the outlet for the vacuum pump is not close to any ignition sources and there is ventilation available.

Charging procedures

In addition to conventional charging procedures, the following requirements shall be followed:

- ① Ensure that contamination of different refrigerants does not occur when using charging equipment. Hoses or lines shall be as short as possible to minimize the amount of refrigerant contained in them. Cylinders shall be kept upright.
- ② Ensure that the refrigeration system is earthed prior to charging the system with refrigerant.
- ③ Label the system when charging is complete (if not already).
- ④ Extreme care shall be taken not to overfill the refrigeration system. Prior to recharging the system it shall be pressure tested with OFN. The system shall be leak tested on completion of charging but prior to commissioning. A follow up leak test shall be carried out prior to leaving the site.

Decommissioning

Before carrying out this procedure, it is essential that the technician is completely familiar with the equipment and all its detail. It is recommended good practice that all refrigerants are recovered safely. Prior to the task being carried out, an oil and refrigerant sample shall be taken in case analysis is required prior to re-use of reclaimed refrigerant. It is essential that electrical power is available before the task is commenced.

- ① Become familiar with the equipment and its operation.
- ② Isolate system electrically.
- ③ Before attempting the procedure ensure that:
 - Mechanical handling equipment is available, if required, for handling refrigerant cylinders;
 - All personal protective equipment is available and being used correctly;

- The recovery process is supervised at all times by a competent person;
- Recovery equipment and cylinders conform to the appropriate standards.
- ④ Pump down refrigerant system, if possible.
- ⑤ If a vacuum is not possible, make a manifold so that refrigerant can be removed from various parts of the system.
- ⑥ Make sure that cylinder is situated on the scales before recovery takes place.
- ⑦ Start the recovery machine and operate in accordance with manufacturer's instructions.
- ⑧ Do not overfill cylinders. (No more than 80 % volume liquid charge).
- ⑨ Do not exceed the maximum working pressure of the cylinder, even temporarily.
- ⑩ When the cylinders have been filled correctly and the process completed, make sure that the cylinders and the equipment are removed from site promptly and all isolation valves on the equipment are closed off.
- ⑪ Recovered refrigerant shall not be charged into another refrigeration system unless it has been cleaned and checked.

Labeling

Equipment shall be labeled stating that it has been decommissioned and emptied of refrigerant. The label shall be dated and signed. Ensure that there are labels on the equipment stating the equipment contains flammable refrigerant.

Recovery

When removing refrigerant from a system, either for servicing or decommissioning, it is recommended good practice that all refrigerants are removed safely. When transferring refrigerant into cylinders, ensure that only appropriate refrigerant recovery cylinders are employed. Ensure that the correct number of cylinders for holding the total system charge are available. All cylinders to be used are designated for the recovered refrigerant and labeled for that refrigerant (i.e. special cylinders for the recovery of refrigerant). Cylinders shall be complete with pressure relief valve and associated shut-off valves in good working order. Empty recovery cylinders are evacuated and, if possible, cooled before recovery occurs.

The recovery equipment shall be in good working order with a set of instructions concerning the equipment that is at hand and shall be suitable for the recovery of flammable refrigerants.

In addition, a set of calibrated weighing scales shall be available and in good working order.





Hoses shall be complete with leak-free disconnect couplings and in good condition. Before using the recovery machine, check that it is in satisfactory working order, has been properly maintained and that any associated electrical components are sealed to prevent ignition in the event of a refrigerant release. Consult manufacturer if in doubt.

The recovered refrigerant shall be returned to the refrigerant supplier in the correct recovery cylinder, and the relevant Waste Transfer Note arranged. Do not mix refrigerants in recovery units and especially not in cylinders.

If compressors or compressor oils are to be removed, ensure that they have been evacuated to an acceptable level to make certain that flammable refrigerant does not remain within the lubricant. The evacuation process shall be carried out prior to returning the compressor to the suppliers. Only electric heating to the compressor body shall be employed to accelerate this process. When oil is drained from a system, it shall be carried out safely.

1.2. The Symbol Description of the Device

The precautions listed here are divided into the following types. They are quite important, so be sure to follow them carefully. Meanings of DANGER, WARNING, CAUTION and NOTE symbols.

Symbols	Meaning	Description
	WARNING	The symbol shows that this appliance uses a flammable refrigerant. If the refrigerant is leaked and exposed to an external ignition source, there is a risk of fire.
	WARNING	The symbol shows that this appliance uses a low burning velocity material. Please keep away from fire source.
	CAUTION	This symbol shows that the operation manual should be read carefully.
	CAUTION	This symbol shows that a service personnel should be handling this equipment with reference to the installation manual.
	CAUTION	This symbol shows that information is available such as the operating manual or installation manual.

1.3. Statement

To keep users under safe working condition and property safety, please follow the instructions below:

- ① Wrong operation may result in injury or damage;
- ② Please install the unit in compliance with local laws, regulations and standards;
- ③ Confirm power voltage and frequency;
- ④ The unit is only used with grounding sockets;
- ⑤ Independent switch must be offered with the unit.

1.4. Safety Factors

The following safety factors need to be considered:

- ① Please read the following warnings before installation;
- ② Be sure to check the details that need attention, including safety factors;
- ③ After reading the installation instructions, be sure to save them for future reference.

Warning

Make sure that the unit is installed safely and reliably.

- If the unit is not secure or not installed, it may cause damage. The minimum support weight required for installation is 21g/mm²
- If the unit was installed in a closed area or limited space, please consider the size of room and ventilation to prevent suffocation caused by refrigerant leakage.
- ① Use a specific wire and fasten it to terminal block so that the connection will prevent pressure from being applied to parts.
- ② Wrong wiring will cause fire.
Please connect power wire accurately according to wiring diagram on the manual to avoid burnout of the unit or fire.
- ③ Be sure to use correct material during installing.
Wrong parts or wrong materials may result in fire, electric shock, or falling of the unit.
- ④ Install on the ground safely, please read installation instructions.
Improper installation may result in fire, electric shock, falling of the unit, or water leaking.
- ⑤ Use professional tools for doing electrical work.
If power supply capacity is insufficient or circuit is not completed, it may cause fire or electric shock.
- ⑥ The unit must have grounding device.
If power supply does not have grounding device, be sure not to connect the unit.
- ⑦ The unit should be only removed and repaired by professional technician.
Improper movement or maintenance of the unit may cause water leakage, electric shock, or fire.
Please find a professional technician to do.
- ⑧ Don't unplug or plug power during operation. It may cause fire or electric shock.
- ⑨ Don't touch or operate the unit when your hands are wet. It may cause fire or electric shock.
- ⑩ Don't place heaters or other electrical appliances near the power wire. It may cause fire or electric shock.
- ⑪ The water must not be poured directly from the unit. Do not let water to permeate into the electrical components.

 **Warning**

- ① Do not install the unit in a location where there may be flammable gas.
- ② If flammable gas around unit, it may cause explosion. Follow drainage system and pipeline work instructions. If defective, water leakage occurs. Dispose immediately to prevent wetting/damaging other household products.
- ③ Do not clean unit with power on. Turn off power before cleaning to avoid fan injury/electric shock.
- ④ Stop unit operation upon problem/fault code. Turn off power to prevent electric shock/fire.
- ⑤ Be careful when unit is unpacked/uninstalled. Watch for sharp edges/fins of heat exchanger.
- ⑥ After installation/repair, confirm no refrigerant leakage. Insufficient refrigerant impairs unit operation.
- ⑦ Install external unit flat and firm to avoid abnormal vibration/noise.
- ⑧ Do not insert fingers into fan/evaporator. High-speed fan causes serious injury.
- ⑨ This device not for physically/mentally weak (incl. children) lacking heating/cooling knowledge. Unless under professional supervision/training. Children use under adult supervision for safety. If power wire damaged, replace by professional to avoid danger.

2. OVER VIEW OF THE UNIT

2.1. Accessories Supplied With the Unit

After unpacking, please check if you have all the following components.

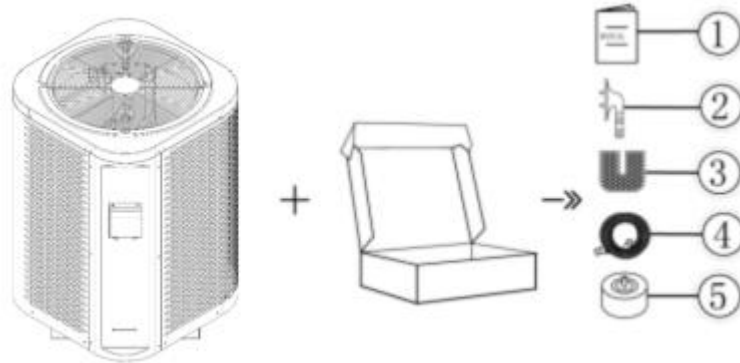

NO.	Components	Quantity	NO.	Components	Quantity
①	User Manual	1	④	Drainage Pipe	1
②	Drainage Spout	1	⑤	Vibration Absorber	4
③	U shaped rubber mat	4	⑥		

2.2. Dimensions of the Unit

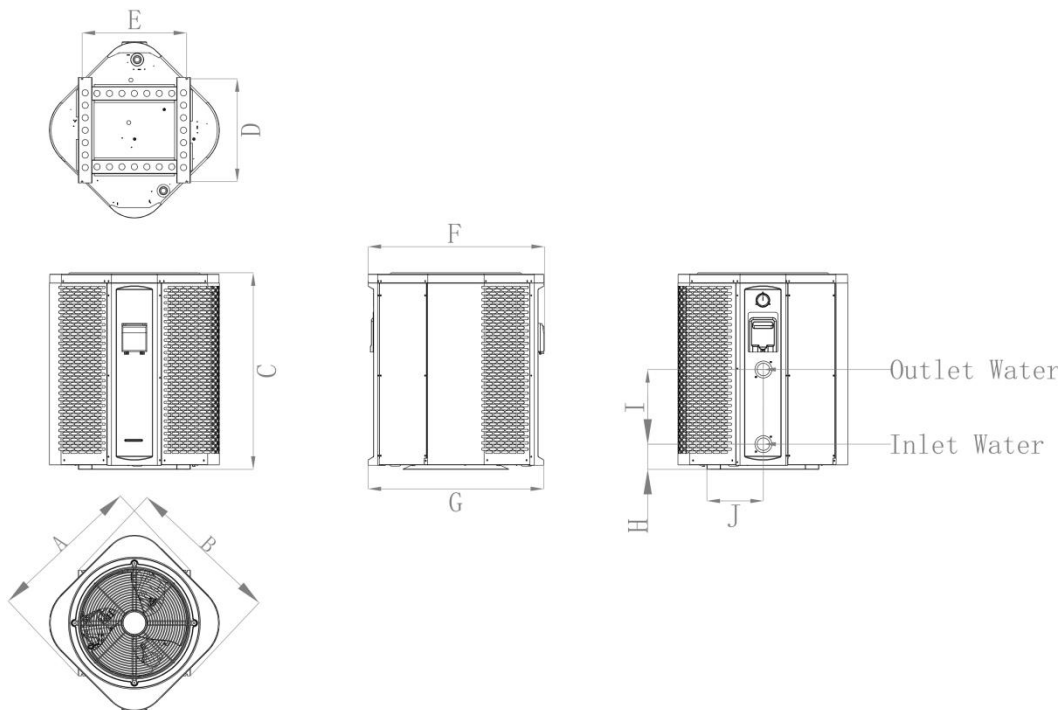

Dimension Unit: (mm)

Model	A	B	C	D	E	F	G	H	I	J
TDI 17	618	618	790	414	420	709	705	102	300	227

2.3. Main Parts of the Unit

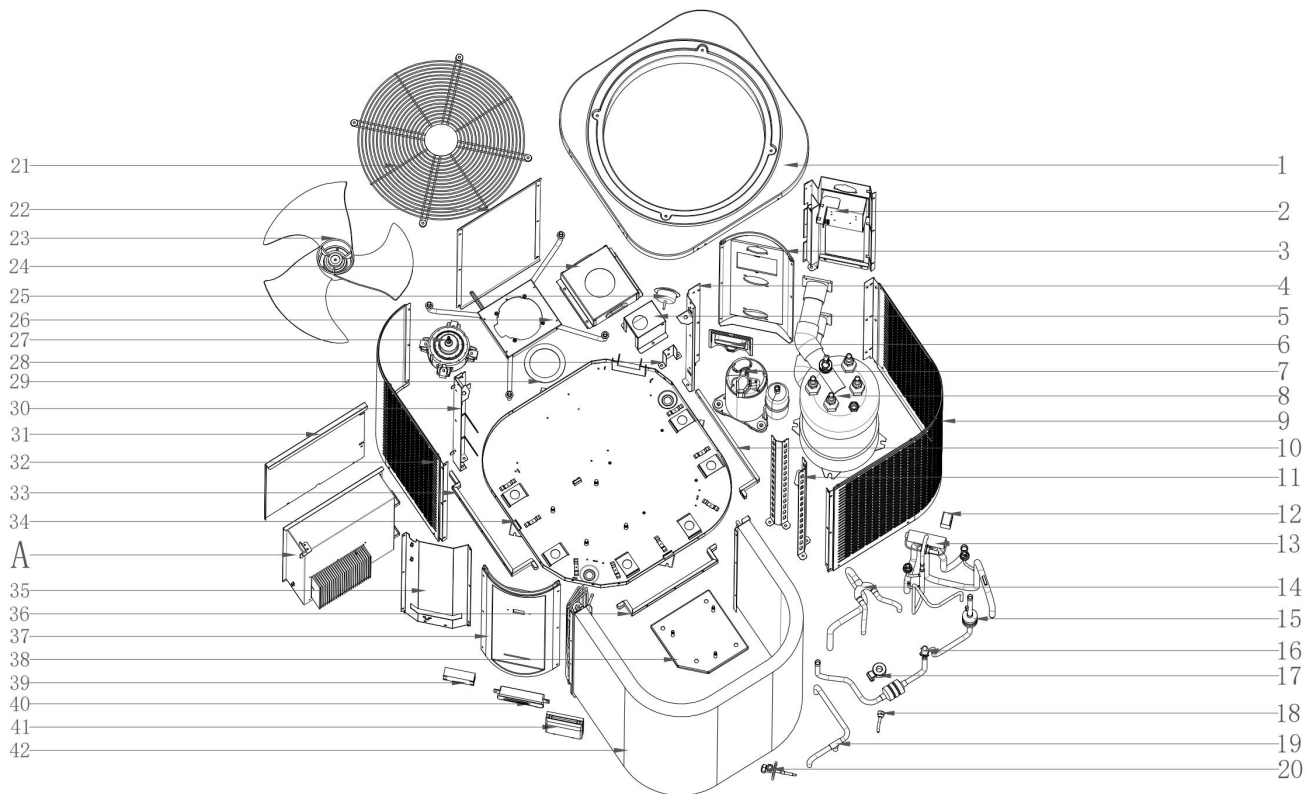

1	Top Cover	15	Throttling Device Assembly	29	Sealing Gasket
2	Back Column	16	EEV	30	Right Column
3	Back Plate	17	EEV Coil	31	Electric Box Cover
4	Left Column	18	Connection Pipe Assembly	32	Right Plate
5	Electrical Box Support Plate	19	Condenser Outlet Pipe Assembly	33	Fixing Plate 3
6	Handle	20	Stop Valve	34	Chassis
7	Compressor	21	Grille Cover	35	Front Column
8	Titanium Heat Exchanger	22	Maintenance Plate	36	Fixing Plate 4
9	Left Plate	23	Fan Blade	37	Front Plate
10	Fixing Plate 1	24	Fan Motor Cover	38	Compressor Support Plate
11	Column	25	Pressure Gage	39	Terminal
12	4-Way Valve Coil	26	Motor Bracket	40	Light Strip
13	4-Way Valve Assembly	27	Fan Motor	41	Wire Controller Wiring Box
14	Condenser Inlet Pipe Assembly	28	Fixing Plate 2	42	Fined Heat Exchanger

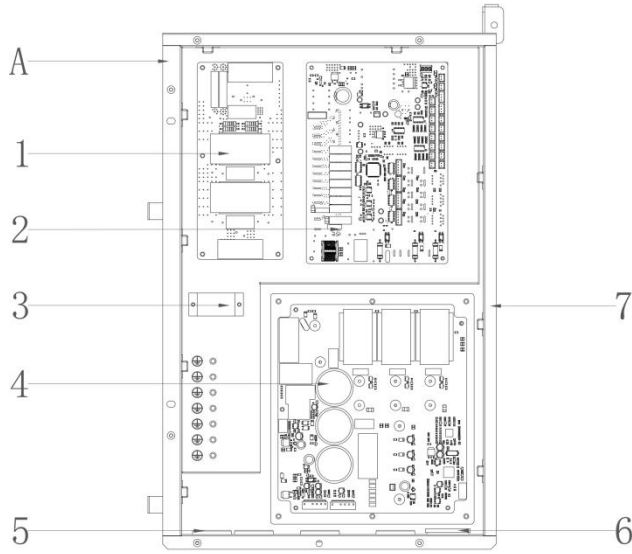

A	Main Control Assembly
1	Filter Board
2	Main Board
3	Current Transformer
4	Driver Board
5	φ 30 Cable Gland
6	φ 50 Cable Gland
7	Electric Box

2.4. Parameter of the Unit

Model:NE-F		TDI 17
Ambient Temperature: (DB/WB) 27°C/24.3°C; Water Inlet/Outlet Temperature: 26°C/28°C.		
Heating Capacity (kW)		3.61~17.1
Consumed Power (kW)		0.18~2.16
COP		19.2~7.88
Boost Mode	Heating Capacity (kW)	17.1
	COP	7.88
Smart Mode	Heating Capacity (kW)	11.11~17.1
	COP	8.00~7.88
Silent Mode	Heating Capacity (kW)	11.11
	COP	8.00
Ambient Temperature: (DB/WB) 15°C/12°C; Water Inlet Temperature: 26°C.		
Heating Capacity (kW)		2.28~12.0
Consumed Power (kW)		0.27~2.28
COP		8.3~5.24
Boost Mode	Heating Capacity (kW)	12.0
	COP	5.24
Smart Mode	Heating Capacity (kW)	7.79~12.0
	COP	6.43~5.24
Silent Mode	Heating Capacity (kW)	7.79
	COP	6.43
Power Supply		220-240V~/50Hz
Max Power Input (kW)		3.1
Max Current(A)		18
Heating Temperature Range(°C)		15~40
Cooling Temperature Range(°C)		8~28
Running Temperature Range(°C)		-15~43
Advised Swimming Pool Size(m³)		54~73
Refrigerant		R32
Compressor		MITSUBISHI ELECTRIC (DC Inverter)
Air Side Heat Exchanger		Hydrophilic Fin Exchanger
Water Side Heat Exchanger		Titanium Tube Heat Exchanger
Water Flow(m³/h)		7.4
Water Pressure Drop (kPa)		21
Net Dimension LxWxH (mm)		618×618×790
Water Pipe Connection (Inlet /Outlet)(mm)		40/50
Net Weight (kg)		69
Noise dB(A)		58
Electric Shock Proof		I
Water Proof Level		IPX4

3. INSTALLATION AND CONNECTION

⚠ WARNING: The heat pump must be installed by a professional team. The users are not qualified to install by themselves, otherwise the heat pump might be damaged and risky for users' safety.

This section is provided for information purposes only and must be checked and adapted if necessary according to the actual installation conditions.

3.1. Transportation

1. When storing or moving the heat pump, the heat pump should be at the upright position.

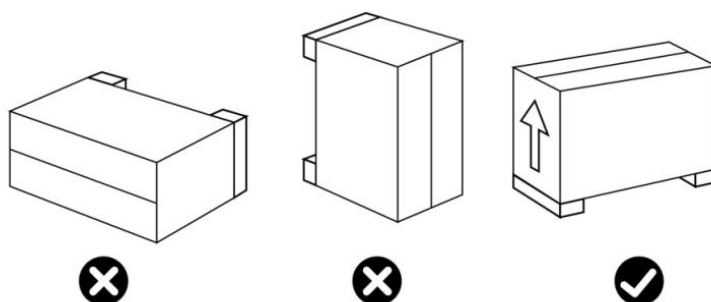

2. When moving the heat pump, do not lift the water union since the titanium heat exchanger inside the heat pump will be damaged.

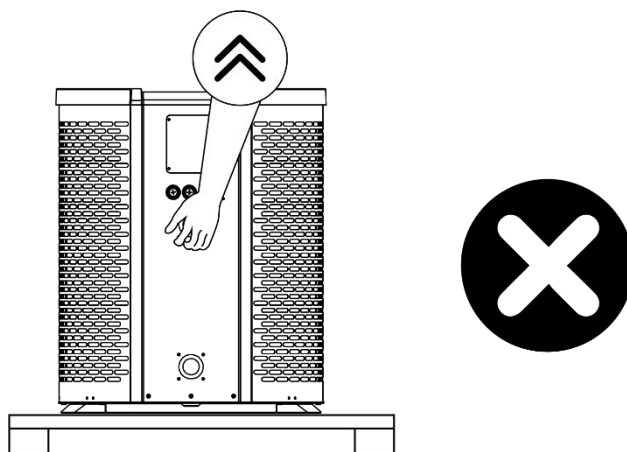

3.2. Notice Before Installation

1. The inlet and outlet water unions can't bear the weight of soft pipes. The heat pump must be connected with hard pipes!

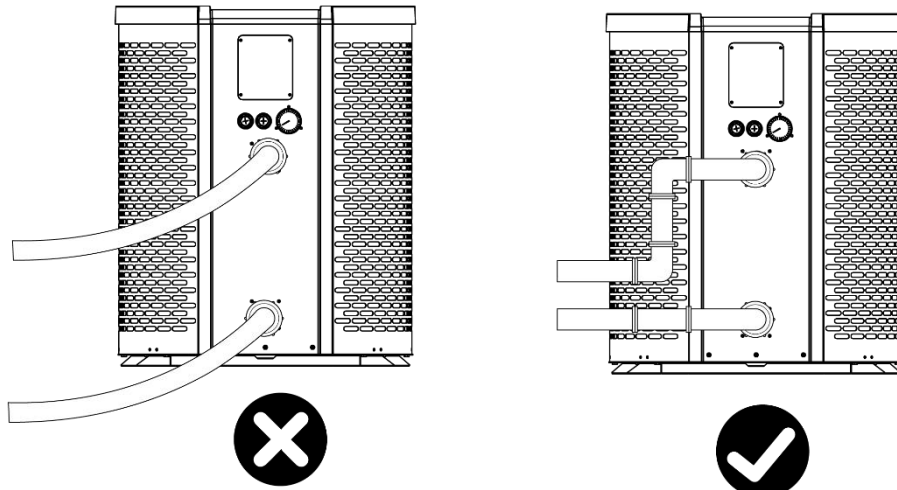

2. In order to guarantee the heating efficiency, the water pipe length should be $\leq 10\text{m}$ between the pool and the heat pump.

3.3. Installation Instruction

3.3.1 Pre-requirements

Equipment necessary for the installation of your heat pump:

- ① Power supply cable suitable for the unit's power requirements.
- ② A By-Pass kit and an assembly of PVC tubing suitable for your installation as well as pvc primer & pvc solvent, PVC adhesive and sandpaper.
- ③ A set of wall plugs and expansion screws suitable to attach the unit to your support.
- ④ Suitable fastening studs may be used to raise the unit.

3.3.2 Heat Pump Installation

- ① The unit can be fixed by bolts (M10) to concrete foundation or brackets. The concrete foundation must be solid; the bracket must be strong enough and anti-rust treated;
- ② The heat pump needs a water pump (Supplied by the user). The recommended pump specification-flux: refer to Technical Parameter, Max. lift $\geq 10\text{m}$;
- ③ When the heat pump is running, there will be condensation water discharged from the bottom, please pay attention to it. Please insert the drainage tube (accessory) into the hole and clip it well, then connect a pipe to drain off the condensation water. Install the heat pump, raising it at least 10 cm with solid water-resistant pads, then connect the drainage pipe to the opening located under the pump.

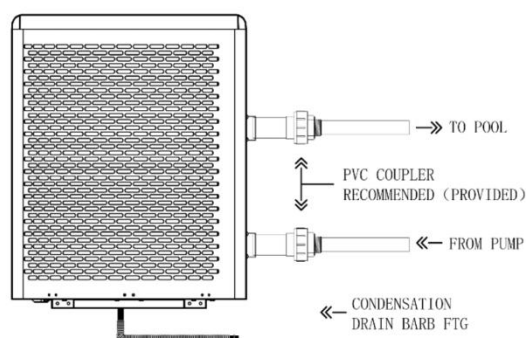

④ There are two methods to fixed heat pump chassis.

Method 1: Sheet metal foot fixed.

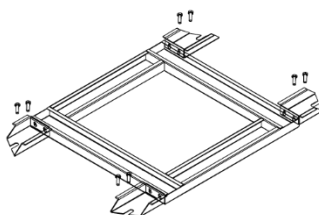

Method 2: Rubber blanket fixed.

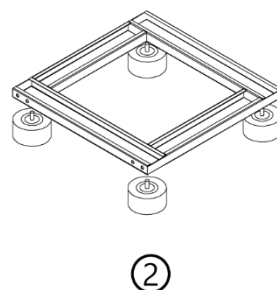
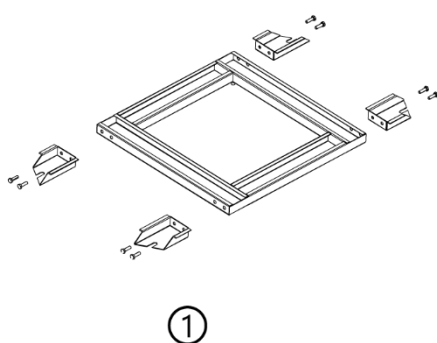

3.3.3 Location and Size

Please comply with the following rules concerning the choice of heat pump location.

- ① The unit's future location must be easily accessible for convenient operation and maintenance.
- ② It must be installed on the ground, fixed ideally on a level concrete floor. Ensure that the floor is sufficiently stable and can support the weight of the unit.
- ③ A water drainage device must be provided close to the unit in order to protect the area where it is installed.
- ④ If necessary, the unit may be raised by using suitable mounting pads designed to support its weight.
- ⑤ Check that the unit is properly ventilated, that the air outlet is not facing the windows of neighbouring buildings and that the exhaust air cannot return. In addition, provide sufficient space around the unit for servicing and maintenance operations.
- ⑥ The unit must not be installed in an area exposed to oil, flammable gases, corrosive products, sulphur compounds or close to high frequency equipment.
- ⑦ To prevent mud splashes, do not install the unit near a road or track.
- ⑧ To avoid causing nuisance to neighbors, make sure the unit is installed so that it is positioned towards the area that is least sensitive to noise.
- ⑨ Keep the unit as much as possible out of the reach of children.
- ⑩ Installation space:

Unit: mm

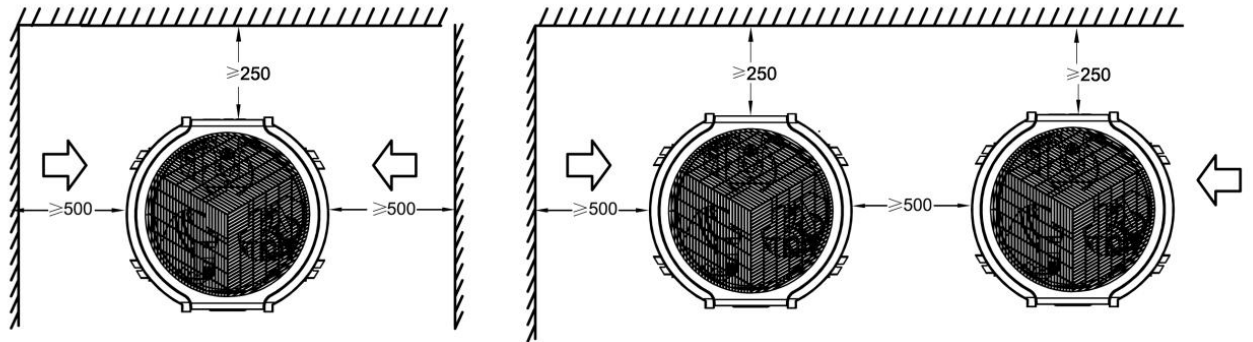

Do not put anything less than one meter in front of the heat pump.

Leave 500 mm of empty space on the sides and back of the heat pump and free ventilation above.

Do not leave any obstacles on the device!

3.3.4 Installation Layout

Notice: The filter must be cleaned regularly to ensure that water in the system is clean and avoid blocking of filter. It is necessary that drainage valve is fixed on the lower water pipe. If the unit is not running during winter months, please disconnect power supply and let out drain water from unit through drainage valve. If ambient temperature of running unit is below 0°C, please keep water pump running.

The installation diagram is shown in the following figure:

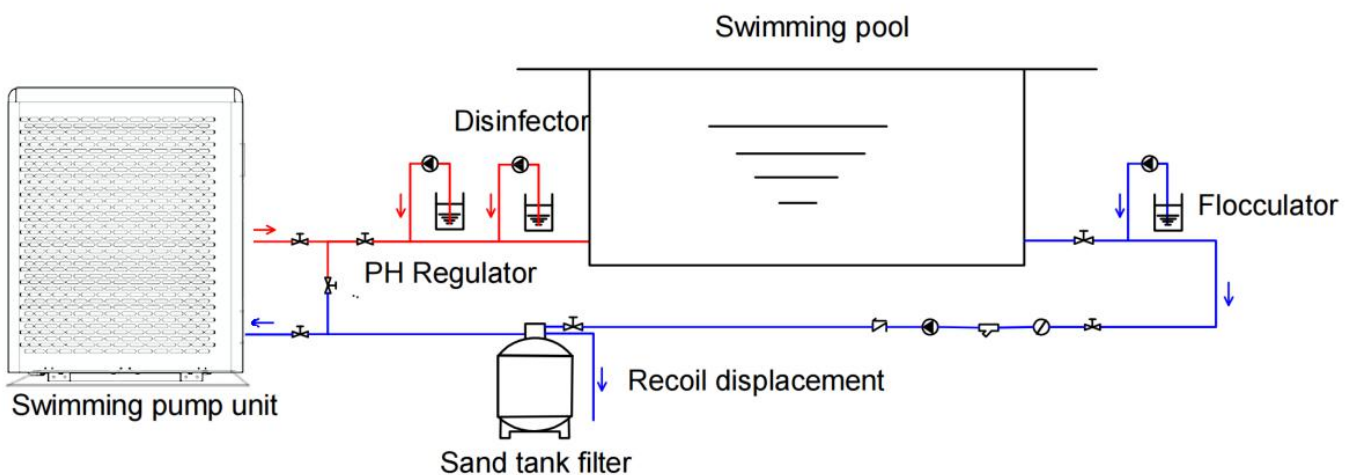

- ☞ Y-type filter ☞ One-way valve ☞ Circulating water pump/Metering pump
- ⊙ Hair collector ☞ Stop valve

No.	Item	Quantity	No.	Item	Quantity
1	Swimming Pump Unit	1	7	PH Regulator	1
2	Y-Type Filter	1	8	Sand Tank Filter	1
3	One-Way Valve	1	9	Flocculator	1
4	Circulating Water Pump	1	10	Disinfector	1
5	Hair Collector	1	11	Metering Pump	3
6	Stop Valve	7			

3.3.5 Electrical Installation

To function safely and maintain the integrity of your electrical system, the unit must be connected to a general electricity supply in accordance with the following regulations:

- ① Upstream, the general electricity supply must be protected by a 30mA differential switch.
- ② The heat pump must be connected to a suitable D-curve circuit breaker in accordance with current standards and regulations in the country where the system is installed.
- ③ The electricity supply cable must be adapted to match the unit's rated power and the length of wiring required by the installation. The cable must be suitable for outdoor use.
- ④ For a three-phase system, it is essential to connect the phases in the correct sequence. If the phases are inverted, the heat pump's compressor will not work.
- ⑤ In places open to the public, it is mandatory to install an emergency stop button close to the heat pump.

Model	Power Supply Wires		
	Electricity Supply	Cable Diameter	Specification
TDI 17	220-240V~/ 50Hz	3G 4mm ²	AWG12

3.3.6 Electrical Connection

⚠ WARNING: Power supply of heat pump must be disconnected before any operation. Please comply with the following instruction to connect heat pump.

Step 1: Detach electrical side panel by a screwdriver to access electrical terminal block.

Step 2: Insert cable into heat pump unit port.

Step 3: Connect power supply cable to terminal block according to the diagram below.

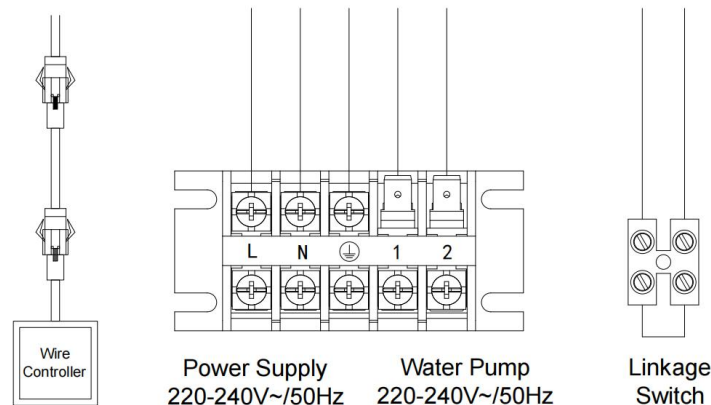

3.4. Trial After Installation

 **WARNING:** Please check all the wiring carefully before turning on the heat pump.

3.4.1 Inspection Before Trial Running

Before running test, confirm below items and write √ in block;

<input type="radio"/>	Correct unit installation
<input type="radio"/>	Power supply voltage is the same as unit rated voltage
<input type="radio"/>	Correct piping and wiring
<input type="radio"/>	Air inlet & outlet port of unit is unblocked
<input type="radio"/>	Drainage and venting is unblocked and no water leaking
<input type="radio"/>	Leakage protector is working
<input type="radio"/>	Piping insulation is working
<input type="radio"/>	Ground wire is connected correctly

3.4.2 Trial Running

Step 1: Running test can begin after completing all installation;

Step 2: All wiring and piping should be connected well and carefully checked, then fill water tank with water before power is switched on;

Step 3: Emptying all air within pipes and water tank, press “on-off” button on control panel to run the unit at setting temperature;

Step 4: Items need to be checked during running test:

- ① During the first running, unit current is normal or not;
- ② Each function button on control panel is normal or not;
- ③ Display screen is normal or not;
- ④ Are there any leakage in the whole heating circulation system;
- ⑤ Condensate drain is normal or not;
- ⑥ Are there any abnormal sound or vibration during running?

4. CONTROLLER OPERATION











4.1. Control Panel Diagram



Basic Icons

- ① Water inlet temperature
- ② ON/OFF
- ③ Mode
- ④ Frequency settings
- ⑤ Lock/Unlock
- ⑥ Target temp. setting
- ⑦ Current faults:

Icon Table:

Icon	Meaning	Remark	Icon	Meaning	Remark
	Networking Status	According to the signal strength display		Fault icon	Blinking
	Heating mode	Dynamic representative unit work		Silent mode	Static
	Automatic mode	Dynamic representative unit work		Powerful mode	Static
	Cooling mode	Dynamic representative unit work		Smart Mode	Static
	Defrosting mode	Static		Remote Icons	Effective flashing

4.2. Key Operating Instruction

4.2.1 Target temperature setting

Click on the target temperature setting icon, then you can enter the value, and finally click on the "OK" button to save it.

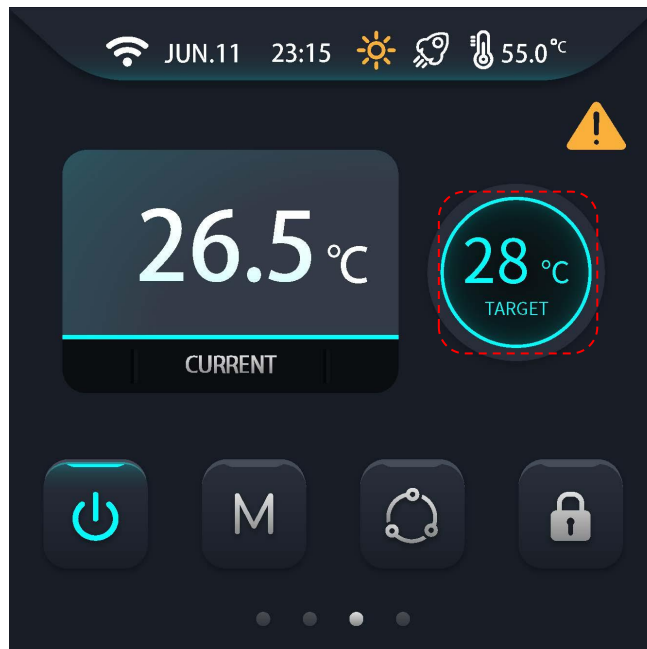





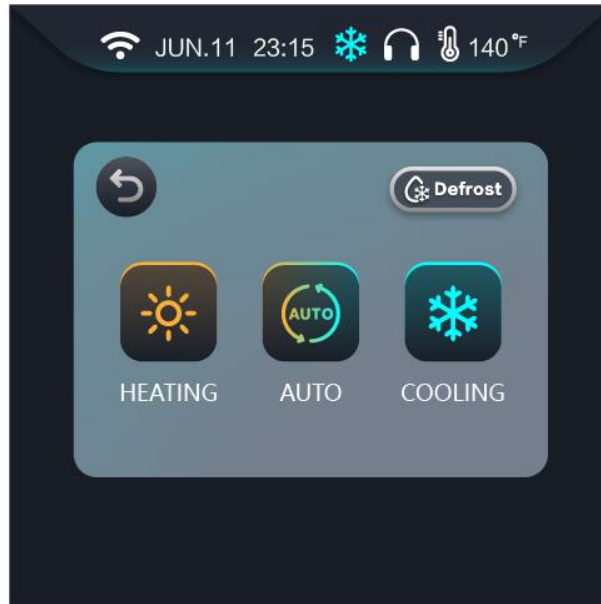

4.2.2 ON/OFF Function

At the main interface, click the “” button to turn the unit ON or OFF.

4.2.3 Mode Selection Function

Click on the “Mode” button to enter mode interface and select the unit operation mode.



- ①  : Heating Mode
- ②  : Automatic Mode
- ③  : Cooling Mode
- ④  : Defrosting
- ⑤  : Return Button

One-Key Defrosting: click “”, the icon will lights up and does not go out until the unit has finished and exits defrost mode.

Notice: Defrosting cannot be performed in cooling mode

4.2.4 Frequency settings

Click the “”button to enter the frequency setting interface.

There are three modes: Powerful, Silent and Smart.

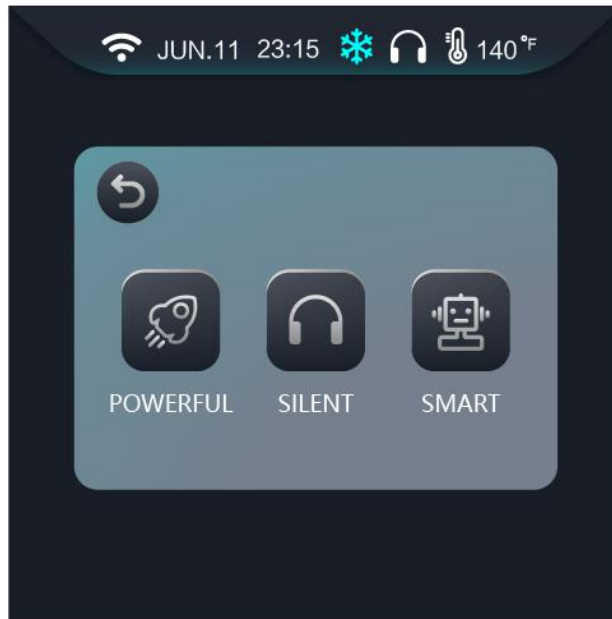

4.2.5 Lock screen function

At the main interface, press “” to lock/unlock.

4.2.6 Current faults

- a. When the unit is malfunctioning, the fault icon “” on the main interface flashes, click on the fault icon to enter the fault inquiry page;
- b. Fault support up to 3 pages of data query, the number of pages displayed according to the number of current fault decision;
- c. The current fault will display fault icon + fault code + fault name.

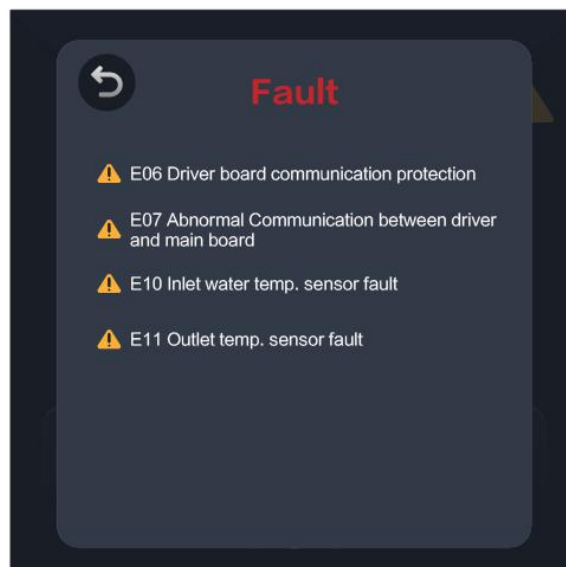

4.2.7 Status Inquiry

- At the main interface, swipe from right to left to check the current running status.
- Click on the triangle icon to view the lower parameters.



4.2.8 Setting interface

Swipe from left to the right at the main interface to enter the settings interface.

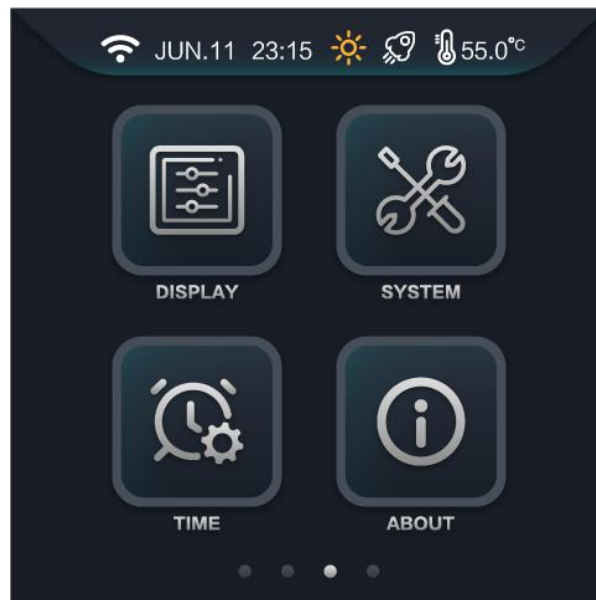

Display Interface

At the settings interface, press “” to enter the display interface.

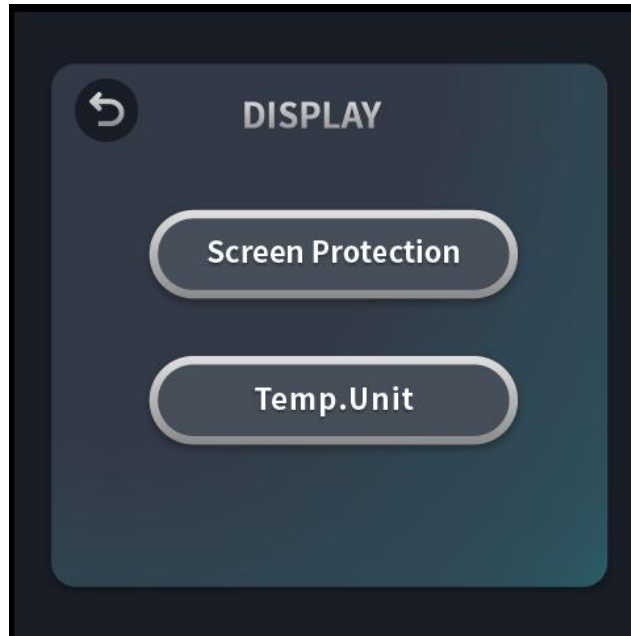

● Screen Protection Interface

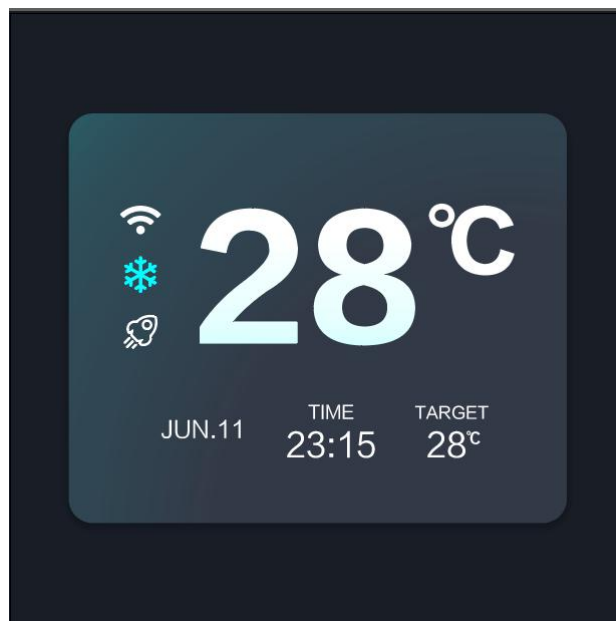

a. The screen protection function is on:

The display will switch to the screen protection interface when there is no operation for five minutes, and then automatically turn off after two minutes without any operation;

b. The screen protection function is off:

The display will automatically turn off after five minutes without any operation.

c. When the display screen is powered off:

a) The screen protection function is on: Click anywhere on the screen, the screen displays the screen protection interface, you need to click on the screen again to exit the screen protection and enter the main interface;

b) The screen protection function is off: click anywhere on the screen, the screen will light up and automatically enter the main interface.

● Temperature unit setting

Click on °C/°F to toggle the temperature unit.



System Parameters

At the settings interface, press “” to enter the password interface.

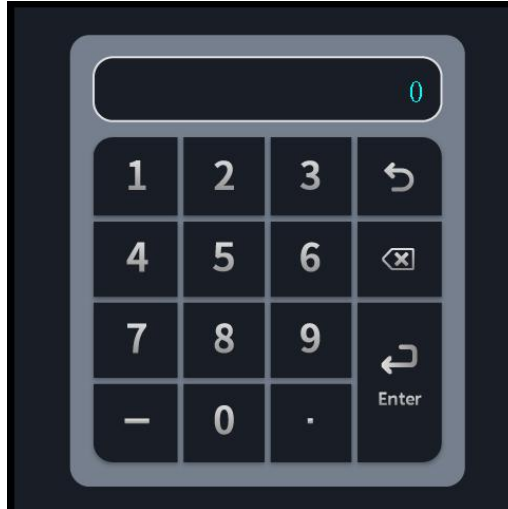

- Restore factory settings

Enter "400866" in the password interface that will automatically pop up a window prompting whether to restore the factory settings;

- User parameter setting

Enter "168" in the password interface to enter the user parameters.

General parameters

- View version number:

Including Display hardware version, display software version and Motherboard Checksum.

- Wi-Fi connection :

Click on the Wi-Fi button, select the internet mode as AP or EZ. And then there will be a QR code for WiFi connection.

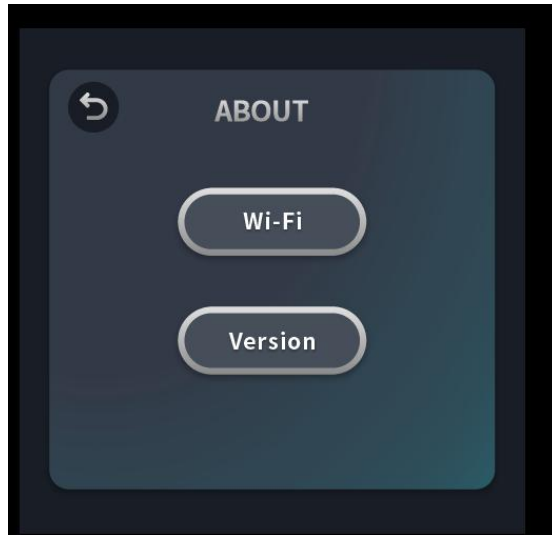

Time settings

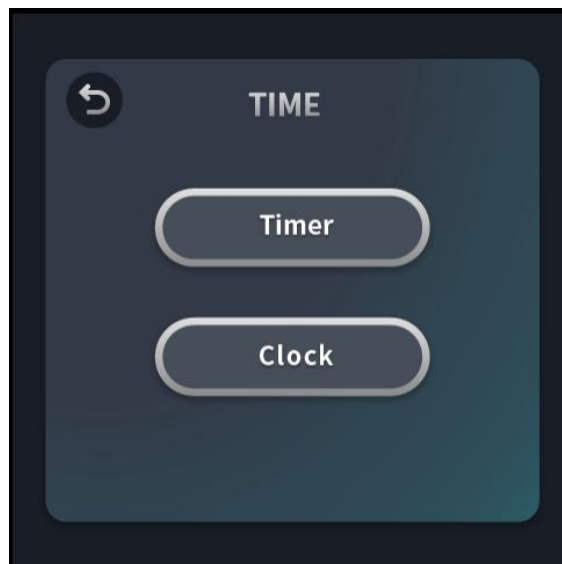

- Timer

Click on “” to enter the Timer ON/OFF setting interface.

- a. Timer on/off setting time range:8*24;
- b. The timer function is not enabled if the timing on is the same as timing off;
- c. The timer function is not enabled when the timer switch is not turned on;
- d. The NO group means timed on, The OFF group means timed off;

- Clock: click on “” to enter the Time setting interface.

Setting rules: Day-Month-Year-Hour:Minute

4.2.9 Curve

- Slide to the rightmost interface to enter the curve display ;
- Refresh curve every hour, display up to 7 data;
- If the power failure more than 7 days, the curve will be cleared; if the power failure does not more than 7 days, the data will be displayed as 0 for the duration of the power failure;
- The latest data of the curve is on the far right.

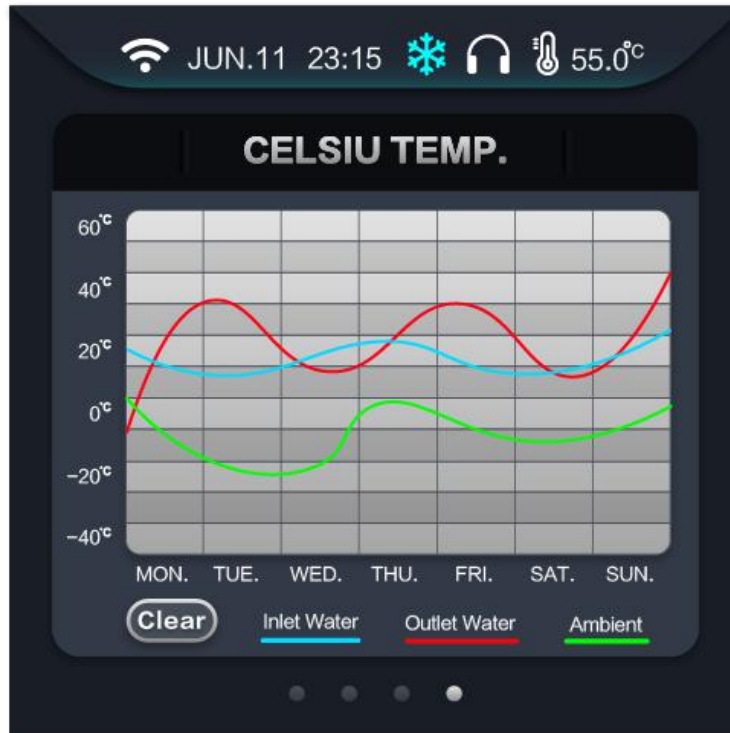

4.3. User Parameters

Para. A (Setting Temperature)

Code	Meaning	Unit	Range
A01	Heating target	℃	20~40
A02	Cooling target	℃	8~30
A03	Automatic target	℃	8~40
A10	Temperature compensation	℃	-10~10℃

Para.B (System Parameters)

Code	Meaning	Unit	Range
B02	Remote monitoring address	/	0~255
B11	LED Light	/	0~1

Para. P (Water Pump Parameter)

Code	Meaning	Unit	Range
P01	Water Pump mode	/	0~5 (0. Keep running at constant Temp. 1. Keep running at constant Temp. for 2 Min. and then off. 2. Run water pump at intervals at constant Temp. 3. Shared unit water pump, keep running at constant Temp. 4. Shared unit water pump, keep running at constant Temp. for 2 Min. and then off. 5. Shared unit pump, run water pump at intervals at constant Temp.)
P02	Pump interval time	/	0~120min

Para. O (Status Parameter)

Code	Meaning	Unit	Range
O01	Water Pump	/	/
O02	Compressor	/	/
O03	Fan High Speed	/	/
O04	4-Way Valve	/	/
O05	Fan Medium Speed	/	/
O06	Fan Low Speed	/	/
O07	DHW Tank Electric Heater	/	/
O08	Crankshaft Electric Heater	/	/
O09	Chassis Heater	/	/
O10	EVI Valve	/	/
O11	Water Supply Valve	/	/
O12	Water Return Valve	/	/

Para. S (Status Parameter)

Code	Meaning	Unit	Range
S01	Linkage switch	/	/
S02	Water Flow Switch	/	/
S03	Low Pressure Switch 1	/	/
S04	High Pressure Switch 1	/	/
S05	Low Water Lever Switch	/	/
S06	High Water Lever Switch	/	/
S07	Low Pressure Switch 2	/	/
S08	High Pressure Switch 2	/	/
S09	Code Switch S1	/	/
S10	Code Switch S2	/	/
S11	Code Switch S3	/	/
S12	Code Switch S4	/	/
S13	Code Switch S5	/	/
S14	Code Switch S6	/	/
S15	Code Switch S7	/	/
S16	Single&Double System	/	/

Para. S (Temp. Status Parameter)

Code	Meaning	Unit	Range
T01	Compressor Frequency	Hz	/
T02	Inlet Water Temp.	°C	/
T03	Coil Temp.	°C	/
T04	Exhaust Temp.	°C	/
T05	Suction temp.	°C	/
T06	Cooling Coil Temp.	°C	/
T07	Ambient Temp.	°C	/
T08	Outlet Water Temp.	°C	/
T09	Main EEV 1 Steps	P	/
T10	AC Voltage	V	/
T11	AC Current	A	/
T12	DC Bus Voltage	V	/
T13	Compressor (Comp.) Current	A	/
T14	IPM Temp.	°C	/
T15	DC Fan 1 Speed	/	/
T16	DC Fan 2 Speed	/	/
T17	DHW Tank Temp.	°C	/
T18	Return Water Temp.	°C	/
T19	Auxiliary EEV 1 Steps	P	/
T20	Main EEV 2 Steps	P	/
T21	Auxiliary EEV 2 Steps	P	/
T22	High Pressure Value	/	/
T23	Low Pressure Value	/	/
T24	High Pressure Saturation Temp.	°C	/
T25	Power consumption within 10 minutes	/	/

4.4. Fault & Protections

When the unit is fault, some faults will cause the display to have an alarm output, and the icon "!" will flash, click the fault icon button to view the current fault.

When another part of the fault occurs, the display will not alarm and the icon "!" will not flash.

"-.-" is displayed when the temperature sensor is fault.

Code	Meaning	Code	Meaning
E01	Wire Controller communication protection	E35	Phase B wrong phase fault
E02	Flow switch fault	E36	Phase C wrong phase fault
E03	High pressure protection	E37	AC current protection
E04	Low pressure protection	E38	AC voltage protection
E06	Driver board communication protection	E39	DC voltage protection
E07	Abnormal Communication between driver and main board	E40	Phase current protection
E10	Inlet water temp. sensor fault	E41	DC current protection
E11	Outlet temp. sensor fault	E42	High pressure sensor fault
E13	Ambient temp. sensor fault	E43	Low pressure sensor fault
E15	Suction temp. sensor fault	F01	AC input current over-current shutdown
E16	Exhaust temp. sensor fault	F02	AC input voltage under-voltage
E17	Outer coil temp. sensor fault(Heating)	F03	Transformer output 15V under-voltage protection
E18	Inner coil temp. sensor fault(Cooling)	F13	IPM temp. overheat protection
E22	High coil temp. protection(Cooling)	F15	Compressor over-current
E23	Low inner coil temp. protection (Cooling)	F20	PFC fault
E24	High outlet water temp. protection (Heating)	F21	IPM fault
E25	Low outlet water temp. Protection (Cooling)	F25	DC bus over-voltage protection
E26	Inlet and outlet water temp. difference protection	F26	DC bus under-voltage protection
E27	High exhaust temp. protection	F38	DC fan 1 fault
E30	Low ambient temp. protection (Heating)	F43	DC fan fault
E30	Low ambient temp. protection (Cooling)	F44	Driver compressor Driver fault
E31	High pressure switch fault	F45	IPM protection (permanent)
E32	Low pressure switch fault	F46	Driver protection(permanent)
E33	Out of phase fault	F47	IPM temp. protection
E34	Phase A wrong phase fault	F48	IPM overheat protection
E49	High Pressure Fault 3 Times Lock	F74	Driver Fault 3 Times Lock

5. Wi-Fi Settings

5.1 Download and Register

- (1) You can download Eco-Home in Google store or Apple store.
- (2) You also can scan up this QR code to download Eco-Home.



- (3) If you have account number, you can just log in, if not, please sign up a new account number.

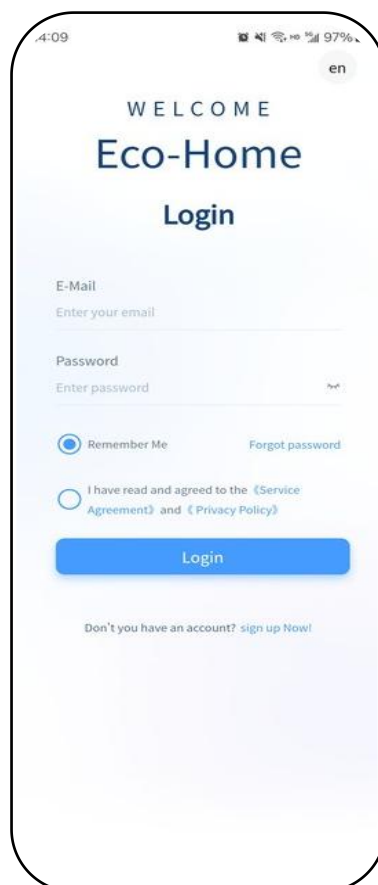



5.2 Add device and share device

- (1) When you in the Eco-Home interface, please click the “+” sign in the upper right corner and insure the WIFI icon of the wire controller is flashing. (If the WIFI icon isn't flashing, please click the WIFI Reset)

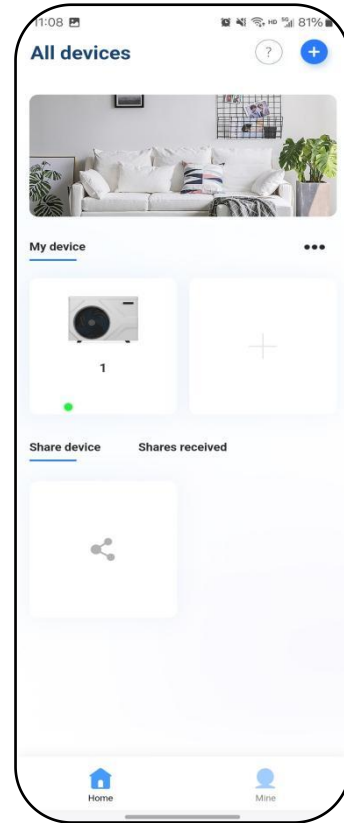
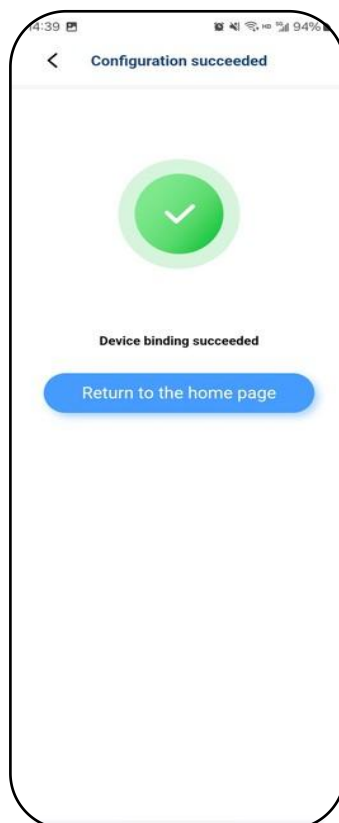
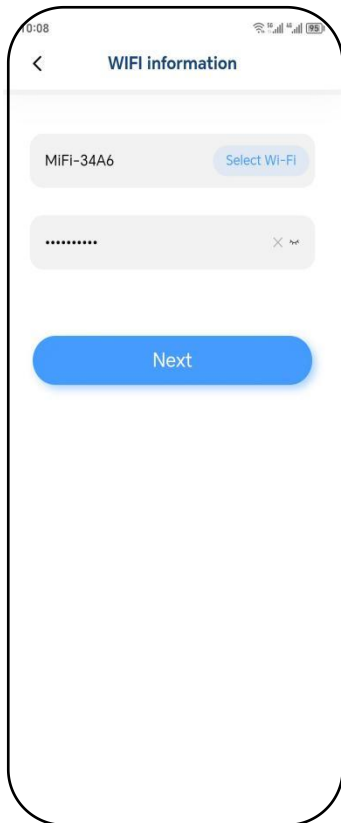

- (2) When you're done with the wire controller, click Confirm on your phone and start the network distribution. Please read the network distribution conditions carefully. Then, the system will automatically identify the WiFi in the WiFi information section.



- (3) When you success,you will see your heat pump in “my device” and if you want to share your device,please click the “  ” icon,and choose your heat pump,add a share and enter Eco-Home account,just click the confirm sharing.



5.3 Software function operation

- After the device is bound successfully, enter the operation interface of “Eco-Home” (Device name, modifiable)
 - In the main interface, click the unit to enter the operation interface.
- (1) Heating & Cooling&Auto

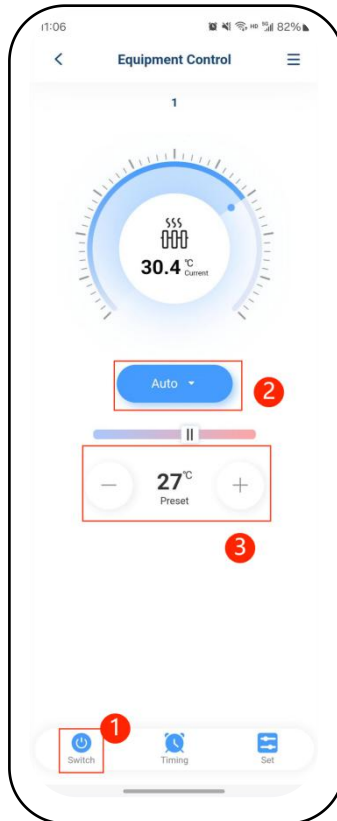

- ① ON/OFF
- ② Mode setting
- ③ Target temperature

(2) Other information

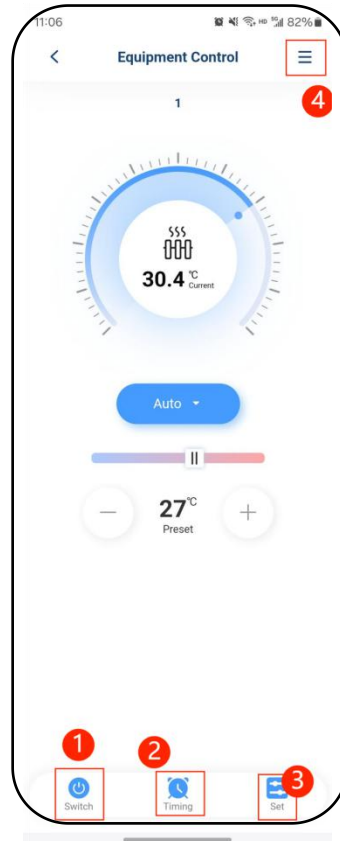

- ① Switch ON/OFF
- ② Timing
- ③ Setting
- ④ More setting

5.4 Modify Device Name/Delete Device

Click in the following order to enter device details, and click "Device Name" to rename the device. Click "Delete the Device" to remove the device.

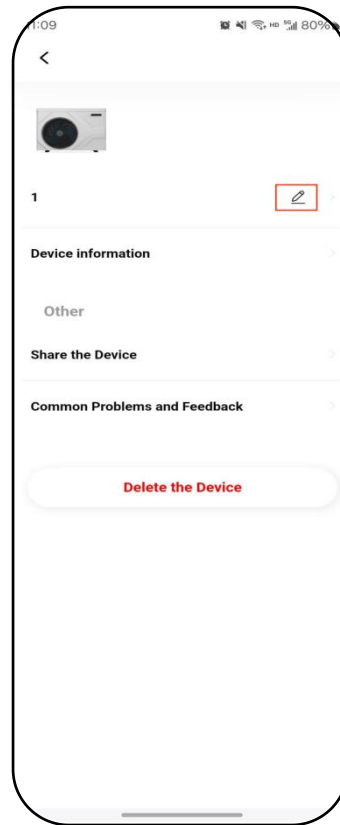
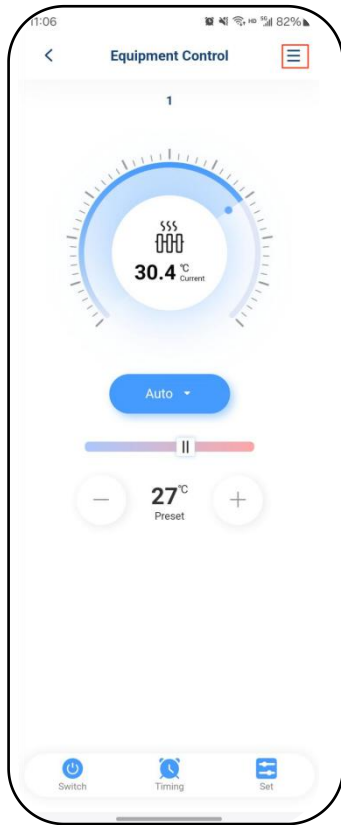

5.5 Timing

Click "Timing", then click "+", set the timer and save it

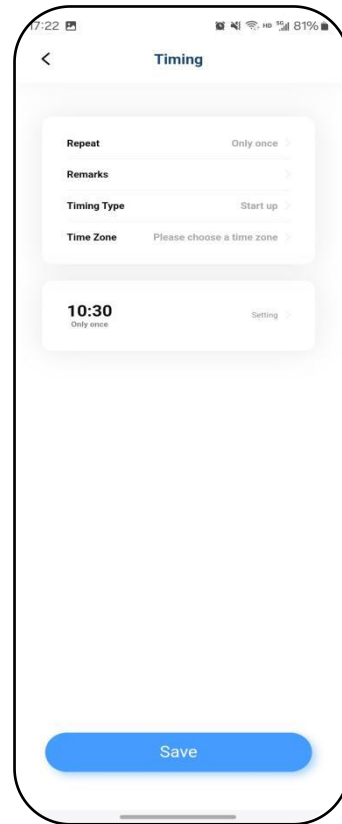
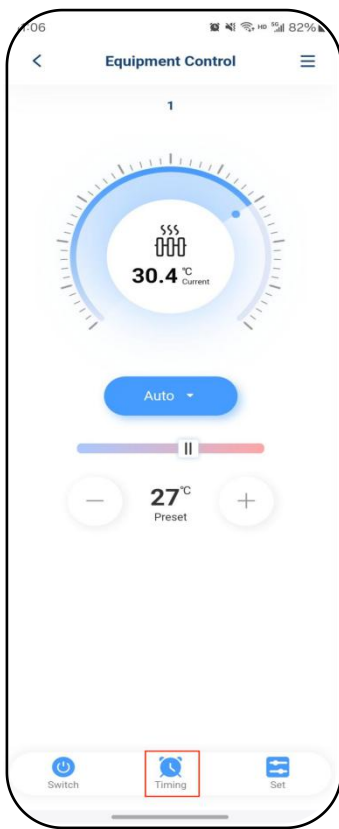

5.6 Set Parameters

(1) Set Target Temp.

Support to modify the content of the parameters is: Hot water target temperature, Cooling target temperature, Heating target temperature, Floor heating target temperature, and temperature units (in the modification of temperature units, the controller will re-read the main board and upload it to the APP one by one).



(2) Status Query

You can query the system status and module status.



(3) Temperature curve.

The current curve shows the temperature respectively: Exchanger water outlet Temperature, Exchanger water inlet Temperature, Ambient Temperature, DHW Temperature. Real-time curve updates.

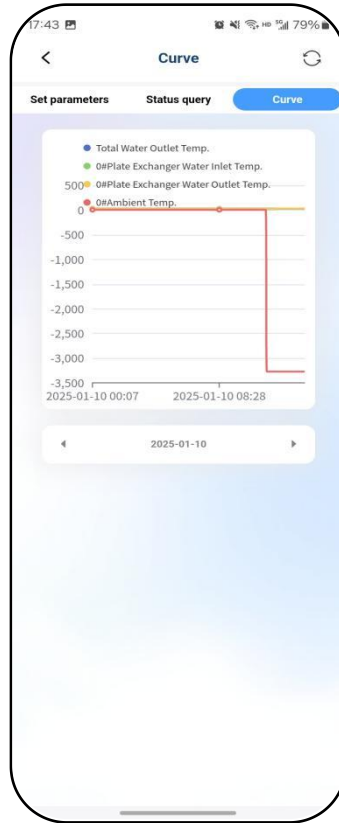

5.7 Mine

Click "Mine" for user information, common problems, about, and logout

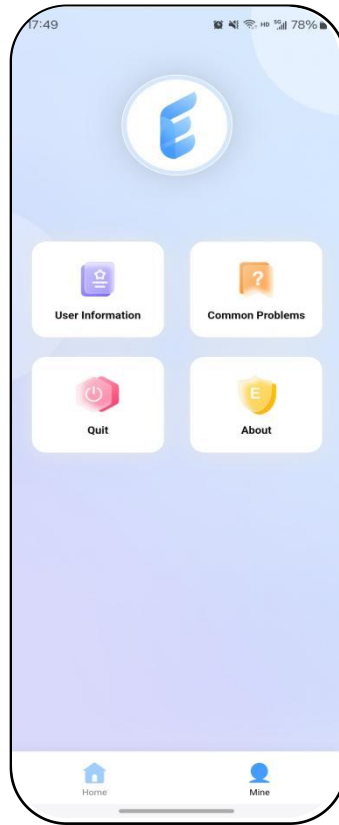

6. MAINTENANCE AND WINTERIZING

6.1 Maintenance

⚠ WARNING: Before undertaking maintenance work on the unit, ensure that you have turned off the unit at the electrical power supply at the isolator and also at the main power board.

1. Cleaning

- The heat pump's casing must be cleaned with a damp cloth. The use of detergents or other household products could damage the surface of the casing and affect its properties.
- The evaporator at the rear of the heat pump must be carefully cleaned with a vacuum cleaner and soft brush attachment.

2. Annual maintenance

The following operations must be undertaken by a qualified person at least once a year.

- Carry out safety checks.
- Check the integrity of the electrical wiring.
- Check the earthing connections.
- Monitor the state of the pressure gauge and the presence of refrigerant.

3. Drainage instruction (Bottom View of the Unit Chassis)

For Machine Chassis Bottom view: The unit has two drain outlets.

One outlet is sealed with a rubber plug before delivery, and the other drain connector is provided in the accessory box for installation.

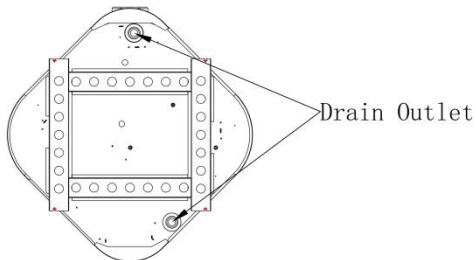

⚠ !! Important:

When the unit runs at an ambient temperature of less than 5°C, please remove the rubber plug of the drain hole of the chassis to ensure its smooth drainage.

6.2 Winterizing



“CUT OFF” power supply of the heater before cleaning, examination and repairing

In winter season when you don't swim:

- Cut off power supply to prevent any machine damage.
- Drain water clear of the machine if in danger of snow or freezing.

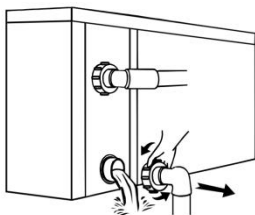

⚠ !! Important:

Unscrew the water nozzle of inlet pipe to let the water flow out. When the water in machine freezes in winter season, the titanium heat exchanger may be damaged.

- Cover the machine body when not in use.

7. Warranty Information

TDI Unit Warranty

30 Years Titanium Heat Exchanger (Pro Rata)

6 Years Compressor

2 Years Electronics

1 Year Labour

Warranty Conditions Apply - to download the latest warranty please visit
www.australianenergysystems.com.au

Contact Information - Australian & NZ Distributor

Australian Energy Systems

Unit 17/6 Maunder St

Slacks Creek Qld

Australia 4127

Phone: 0732992700

Web: www.australianenergysystems.com.au

